



LM Guide

Separate Type

HR



Separate Type LM Guide

HR

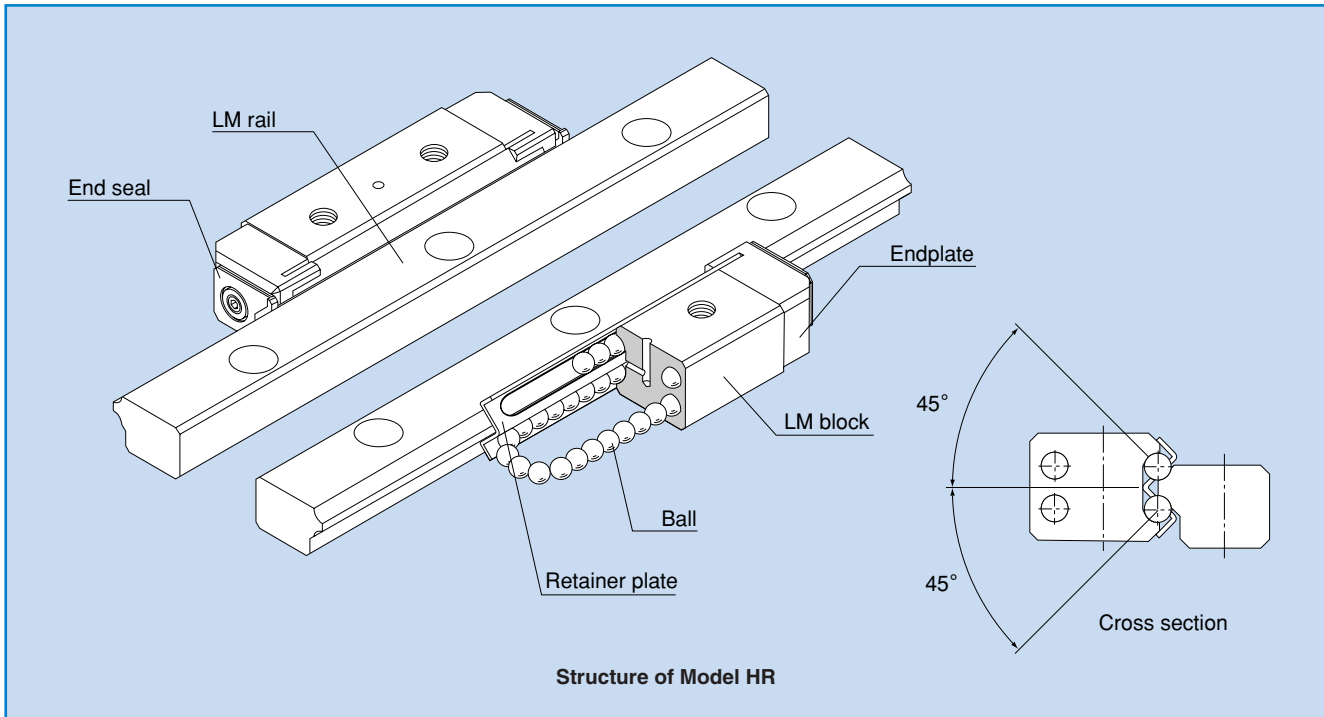

Balls roll in two rows of raceways precision-ground on an LM rail and an LM block, and endplates incorporated in the LM block allow the balls to circulate. Since retainer plates hold the balls, they do not fall off.

Because of the angular contact structure where two rows of balls rolling on the LM rail each contact the raceway at 45°, the same load can be applied in four directions (radial, reverse-radial and lateral directions) if a set of model HR components is mounted on the same plane (i.e., when two LM rails are combined with LM blocks on the same plane). Furthermore, since the sectional height is low, a compact and stable linear guide mechanism is achieved.

This structure makes clearance adjustment relatively easy, and is highly capable of absorbing a mounting error.

● Easy installation

The clearance of model HR is easier to adjust and thus achieves better accuracy than Cross Roller Guides.

● Self-adjustment capability

Even if the parallelism or the level between the two rails is poorly established, the self-adjustment capability through Face-to-Face configuration of THK's unique circular-arc grooves (DF set) enables a mounting error to be absorbed and smooth linear motion to be achieved even under a preload.

● 4-way equal-load type

When the two rails are mounted in parallel, each row of balls is placed at a contact angle of 45° so that the rated loads applied to the LM block are uniform in the four directions (radial, reverse-radial and lateral directions), enabling the LM Guide to be used in all orientations and in extensive applications.

● Sectional dimensions approximate to that of Cross Roller Guides

Since model HR is an infinite motion type whose retainer plate does not move, it is not associated with cage displacement that occurs with Cross Roller Guides. In addition, the sectional shape of model HR is approximate to that of Cross Roller Guides, and therefore, its components are interchangeable with that of Cross Roller Guides.

● Stainless steel type also available

A special type whose LM block, LM rail and balls are made of stainless steel is also available.

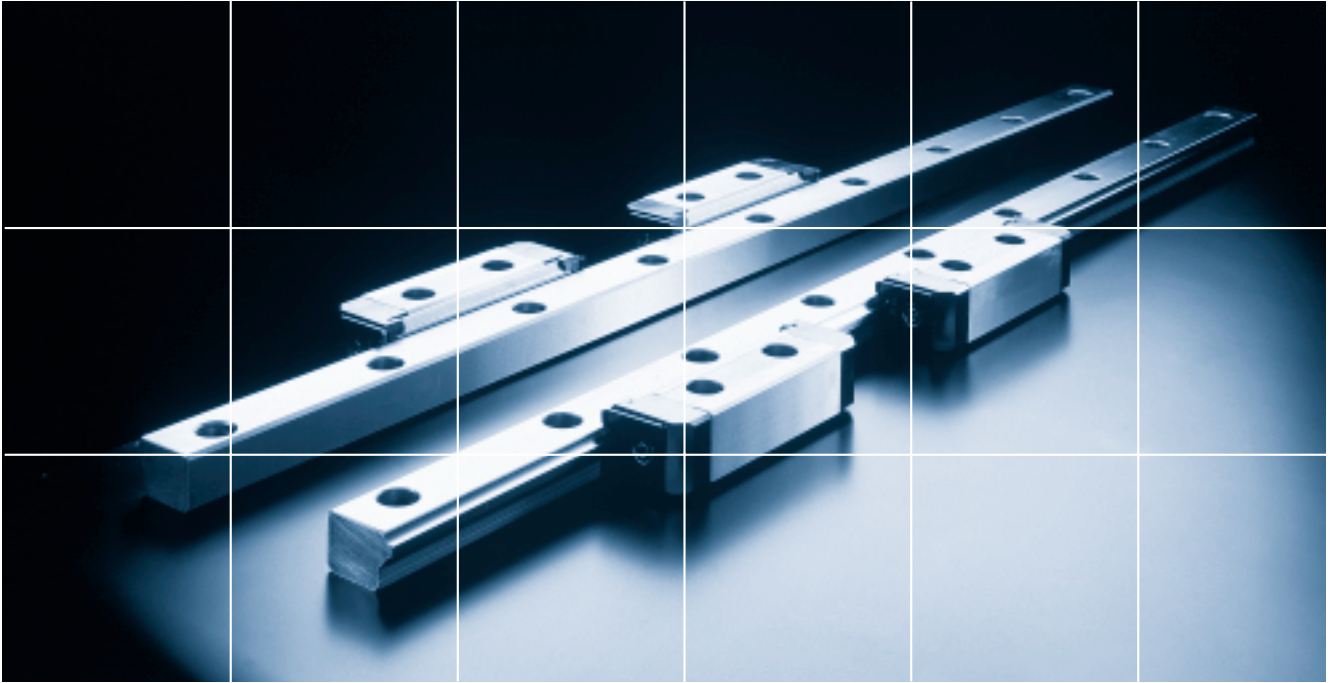

HR Outline

Model HR - Product Overview

With a thin, highly rigid and space saving structure, model HR is interchangeable with the Cross Roller Guide.

A stainless steel type is also available as standard.

Major applications XYZ axes of electric discharge machine / precision table / XZ axes of NC lathe / assembly robot / conveyance system / machining center / wire-cutting electric discharge machine / tool changer / woodworking machine

Model HR Heavy-load Type

The LM blocks can be mounted from the top and the bottom.

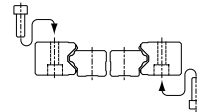
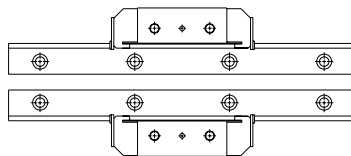

Model HR-T Ultra-heavy Load Type

It has the same sectional shape as model HR, but has a greater overall LM block length (L) and a higher load rating.

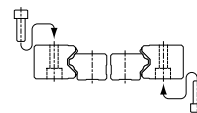
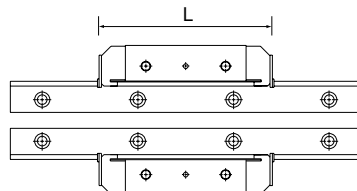

Rated Loads in All Directions

When installed, one set of model HR is capable of receiving loads in all four directions: radial, reverse-radial and lateral directions.

The basic load ratings of an installed set of model HR are equal in all four directions (radial, reverse-radial and lateral directions). The basic load ratings in the dimensional table*1 for model HR indicate the values in the radial direction per LM block as shown in the figure on the right.

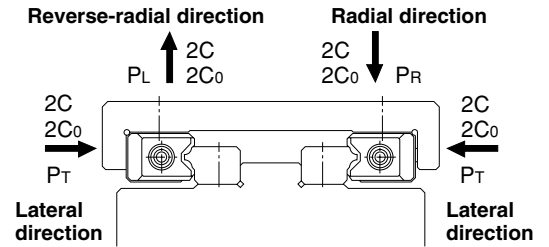

Equivalent Load

When the LM block of model HR receives loads in the reverse-radial and lateral directions simultaneously, the equivalent load is obtained from the equation below.

$$P_E = P_R(P_L) + \frac{1}{2}P_T$$

where

P_E :Equivalent load	(N)	P_R :Radial load	(N)
·Radial direction		P_L :Reverse-radial load	(N)
·Reverse-radial direction		P_T :Lateral load	(N)
·Lateral direction			

Service life

The service life of an LM Guide is subject to variations even under the same operational conditions. Therefore, it is necessary to use the rated life defined below as a reference value for obtaining the service life of the LM Guide.

Rated life

The rated life means the total travel distance that 90% of a group of units of the same LM Guide model can achieve without flaking (scale-like exfoliation on the metal surface) after individually running under the same conditions.

Service life time

Once the rated life (L) has been obtained, the service life time can be obtained using the equation on the right if the stroke length and the number of reciprocations are constant.

*1: Basic dynamic load rating (C)

It refers to a load with a constant magnitude and direction under which the rated life (L) of a group of identical LM Guide units independently operating is 50 km.

$$L = \left(\frac{f_H \cdot f_T \cdot f_C}{f_W} \cdot \frac{C}{P_C} \right)^3 \times 50$$

- L : Rated life (km)
- C : Basic dynamic load rating*1 (N)
- P_C : Calculated load (N)
- f_H : Hardness factor (see Fig. 1)
- f_T : Temperature factor (see Fig. 2)
- f_C : Contact factor (see Table 1)
- f_W : Load factor (see Table 2)

$$L_h = \frac{L \times 10^6}{2 \times \ell_s \times n_1 \times 60}$$

- L_h : Service lifetime (h)
- ℓ_s : Stroke length (mm)
- n₁ : No. of reciprocations per min (min⁻¹)

f_H : Hardness factor

To ensure the achievement of the optimum load capacity of the LM Guide, the raceway hardness must be between 58 and 64 HRC. At hardness below this range, the basic dynamic and static load ratings decrease. Therefore, the rating values must be multiplied by the respective hardness factors (f_H). Since the LM Guide has sufficient hardness, the f_H value for the LM Guide is normally 1.0 unless otherwise specified.

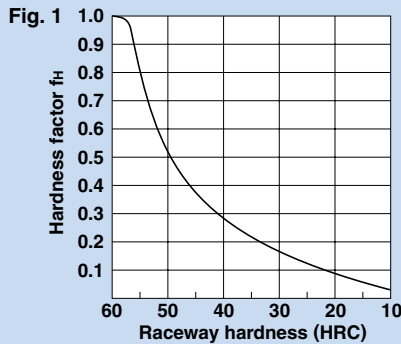

f_T : Temperature factor

Since the service temperature of Caged Ball LM Guides is normally 80°C or below, the f_T value is 1.0.

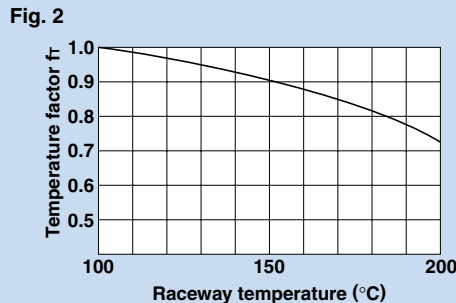

f_C : Contact factor

When multiple LM blocks are used in close contact with each other, it is difficult to achieve uniform load distribution due to moment loads and mounting-surface accuracy. When using multiple blocks in close contact with each other, multiply the basic load rating (C or C₀) by the corresponding contact factor indicated in Table 1.

Note: When uneven load distribution is expected in a large machine, consider using a contact factor from Table 1.

Table 1 Contact Factor (f_C)

Number of blocks used in close contact	Contact factor f _C
2	0.81
3	0.72
4	0.66
5	0.61
6 or more	0.6
Normal use	1

f_W : Load factor

In general, reciprocating machines tend to produce vibrations or impact during operation. It is especially difficult to accurately determine all vibrations generated during high-speed operation and impacts produced each time the machine starts and stops. Therefore, where the effects of speed and vibration are estimated to be significant, divide the basic dynamic load rating (C) by a load factor selected from Table 2, which contains empirically obtained data.

Table 2 Load Factor (f_W)

Vibration/impact	Speed (V)	f _W
Faint	Very slow V ≤ 0.25m/s	1 to 1.2
Weak	Slow 0.25 < V ≤ 1m/s	1.2 to 1.5
Moderate	Medium 1 < V ≤ 2m/s	1.5 to 2
Strong	Fast V > 2m/s	2 to 3.5

Example of Clearance Adjustment

Design the clearance adjustment screw so that it presses the center of the side face of the LM block.

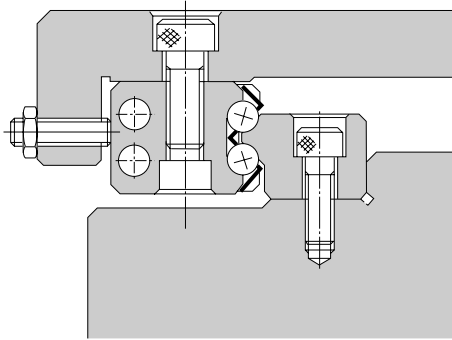

Using a clearance screw

Normally, press the LM block with an adjusting screw.

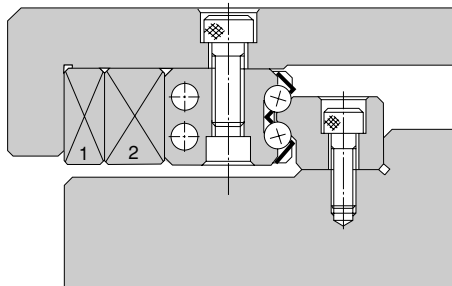

Using tapered gibs

When high accuracy and high rigidity are required, use tapered gibs 1) and 2).

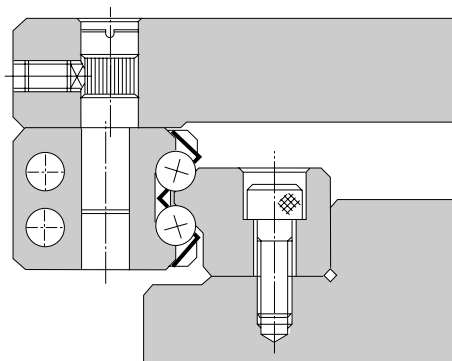

Using an eccentric pin

THK manufactures a type whose clearances are adjusted with an eccentric pin.

Accuracy Standard

The accuracy of model HR is specified in terms of running parallelism (*1), dimensional tolerance for height and width, and height and width difference between a pair (*2, *3) when two or more LM blocks are used on one rail or when two or more rails are mounted on the same plane.

The accuracy of model HR is defined by model numbers as indicated in the table below.

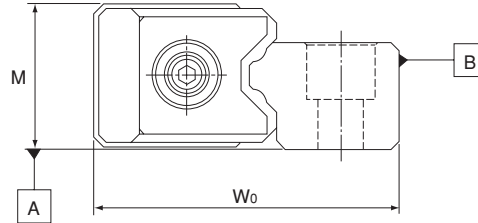

Unit: mm

Accuracy standard	Normal grade	High-accuracy grade	Precision grade	Super-precision grade	Ultra-super precision grade
Item	No symbol	H	P	SP	UP
Dimensional tolerance for height M	±0.1	±0.05	±0.025	±0.015	±0.01
Difference in height M (see note 1)	0.03	0.02	0.01	0.005	0.003
Dimensional tolerance for total width W ₀	±0.1		±0.05		
Difference in total width W ₀ (see note 2)	0.03	0.015	0.01	0.005	0.003
Running parallelism of surface B against surface A	ΔC (as shown in the figure below)				

Note 1: Difference in height M applies to a set of model HR components used on the same plane.

Note 2: Difference in total width W₀ applies to LM blocks used in combination on one LM rail.

Note 3: Dimensional tolerance and difference in total width W₀ for precision and higher grades apply only to the master-rail side among a set of model HR components. The master rail is imprinted with "KB" following a serial number.

*1: Running parallelism

It refers to the parallelism error between the LM block and the LM rail datum plane when the LM block travels the whole length of the LM rail with the LM rail secured on the reference datum plane using bolts.

*2: Difference in height M

It indicates the difference between the minimum and maximum values of height (M) of each of the LM blocks used on the same plane in combination.

*3: Difference in width W₀

It indicates the difference between the minimum and maximum values of the width (W₀) between each of the LM blocks, mounted on one LM rail in combination, and the LM rail.

LM Rail Length and Running Parallelism for Model HR

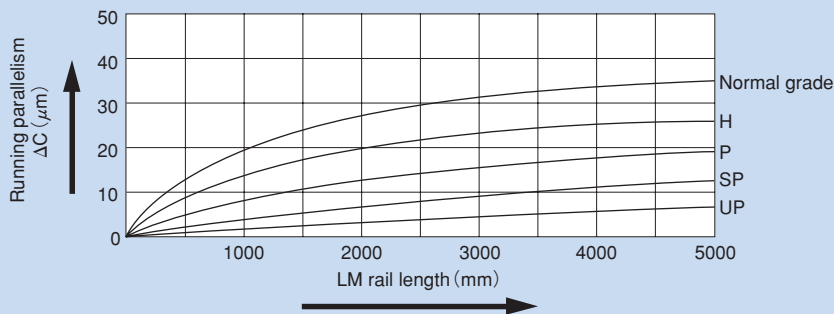

Shoulder Height of the Mounting Base and the Corner Radius

Normally, the mounting base for the LM rail and the LM block has a datum plane on the side face of the shoulder of the base in order to allow easy installation and highly accurate positioning.

The corner of the mounting shoulder must be machined to have a recess, or machined to be smaller than the corner radius "r," to prevent interference with the chamfer of the LM rail or the LM block.

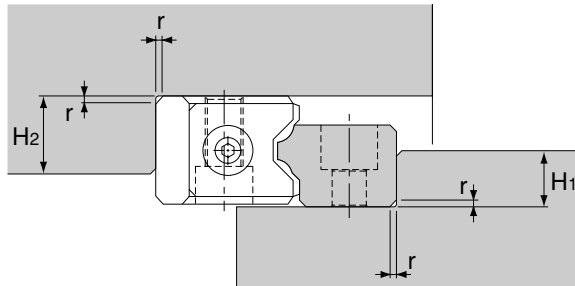

Unit: mm

Model No.	Corner radius r (max)	Shoulder height for the LM rail H ₁	Shoulder height for the LM block H ₂
918	0.3	5	6
1123	0.5	6	7
1530	0.5	8	10
2042	0.5	11	15
2555	1	13	18
3065	1	16	20
3575	1	18	26
4085	1.5	21	30
50105	1.5	26	32
60125	1.5	31	40

Error Allowance in the Parallelism Between Two Rails

The following table shows error allowances in parallelism (P) between two rails that will not affect the service life in normal operation.

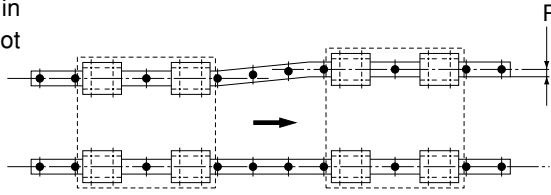

Unit: μm

Model No.	Clearance C0	Clearance C1	Normal clearance
918	—	7	10
1123	—	8	14
1530	—	12	18
2042	14	15	20
2555	20	24	35
3065	22	26	38
3575	24	28	42
4085	30	35	50
50105	38	42	55
60125	50	55	65

Error Allowance in Vertical Level Between Two Rails

The values in the table each indicate the error allowances in vertical level between two rails per 500 mm of the axis-to-axis distance, and are proportional to the axis-to-axis distances.

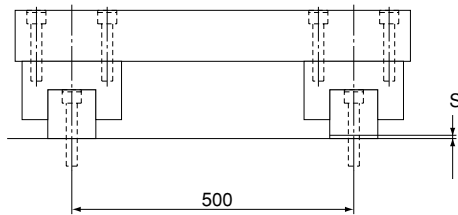

Unit: μm

Model No.	Clearance C0	Clearance C1	Normal clearance
918	—	15	45
1123	—	20	50
1530	—	60	90
2042	50	60	90
2555	85	100	150
3065	95	110	165
3575	100	120	175
4085	120	150	210
50105	140	175	245
60125	170	200	280

Comparison of Model Numbers with Cross Roller Guides

Each type of LM Guide model HR has sectional dimensions approximate to that of the corresponding Cross Roller Guide model.

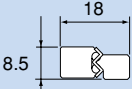
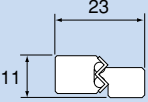
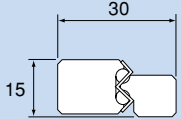
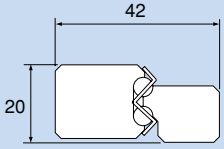
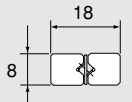
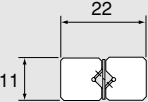
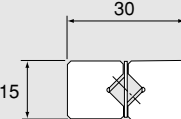
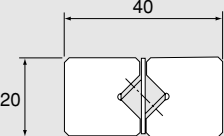
Model HR	 <p style="text-align: center;">HR918</p>	 <p style="text-align: center;">HR1123</p>	 <p style="text-align: center;">HR1530</p>	 <p style="text-align: center;">HR2042</p>
Cross Roller Guide	 <p style="text-align: center;">VR3</p>	 <p style="text-align: center;">VR4</p>	 <p style="text-align: center;">VR6</p>	 <p style="text-align: center;">VR9</p>

HR OUTLINE
Model HR - Product Overview

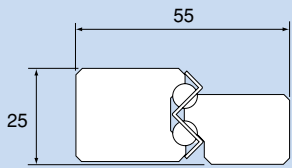

HR2555

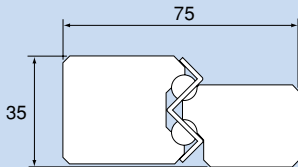

HR3575

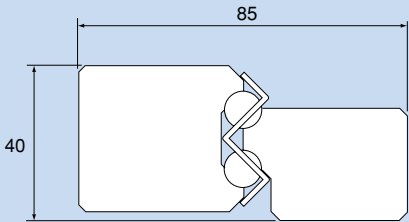

HR4085

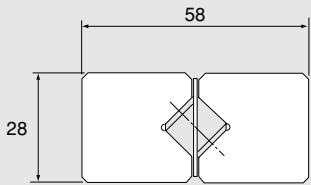

VR12

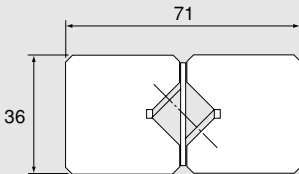

VR15

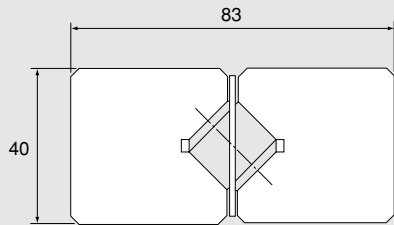

VR18

Models HR/HR-T/HR-M/HR-TM

Dimensional Table for Models HR/HR-T/HR-M/HR-TM

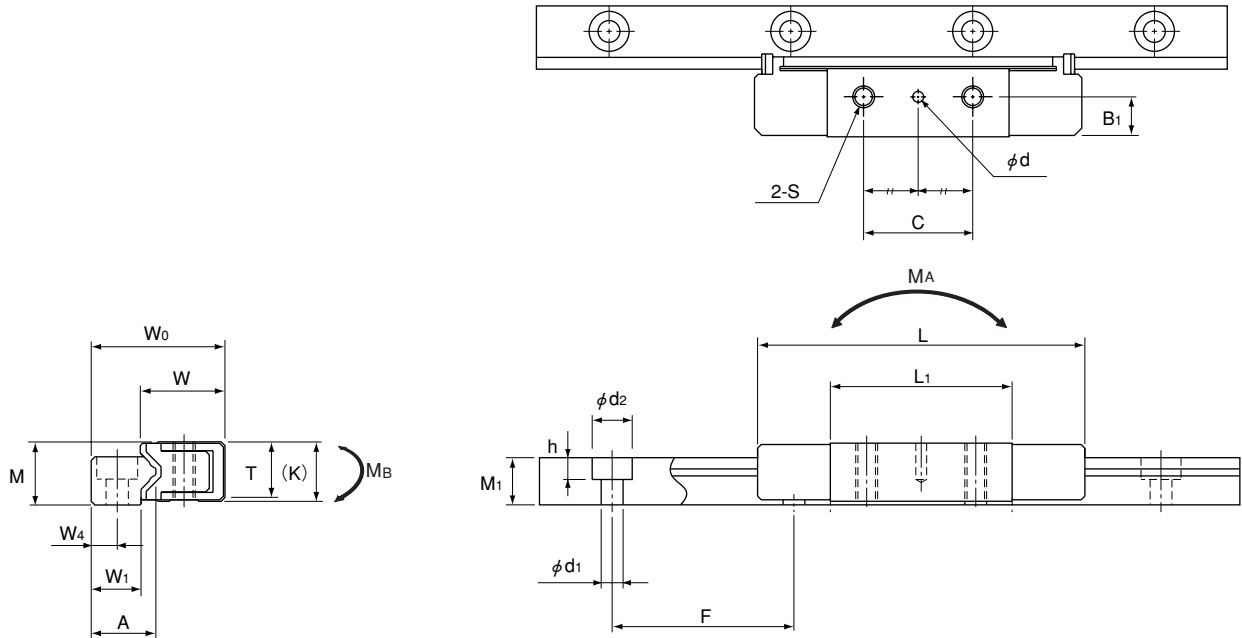

Models HR918, 918M

Model No.	External dimensions				LM block dimensions									
	Height M	Width W	W_0	Length L	B_1	C	H	S	h_2	L_1	T	K	Greasing hole d	D_1
HR 918 HR 918M	8.5	11.4	18	45	5.5	15	—	M3	—	25	7.5	8	1.5	—
HR 1123 HR 1123M	11	13.7	23	52	7	15	2.55	M3	3	30	9.5	10	2	5
HR 1530 HR 1530M	15	19.2	30	69	10	20	3.3	M4	3.5	40	13	14	2	6.5
HR 2042 HR 2042M	20	26.3	42	91.6	13	35	5.3	M6	5.5	56.6	17.5	19	3	10
HR 2042T HR 2042TM	20	26.3	42	110.7	13	50	5.3	M6	5.5	75.7	17.5	19	3	10
HR 2555 HR 2555M	25	33.3	55	121	16	45	6.8	M8	7	80	22.5	24	3	11
HR 2555T HR 2555TM	25	33.3	55	146.6	16	72	6.8	M8	7	105.4	22.5	24	3	11

Note Symbol M indicates that stainless steel is used in the LM block, LM rail and balls. Those models marked with this symbol are therefore highly resistant to corrosion and environment.

■ Example of model number coding

2 HR2555 UU M +1000L P M

1 2 3 4 5 6 7

1 No. of LM blocks used on the same rail 2 Model number 3 Dust prevention accessory symbol (see page 17)
4 LM block is made of stainless steel 5 LM rail length (in mm) 6 Accuracy symbol (see page 6) 7 LM rail is made of stainless steel

Note One set of model HR means a combination of two LM rails and LM blocks used on the same plane.

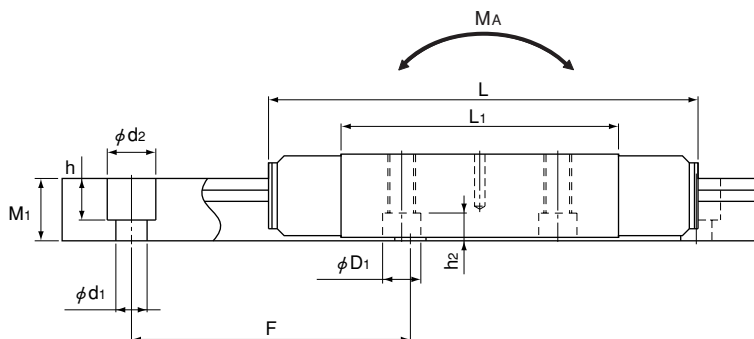
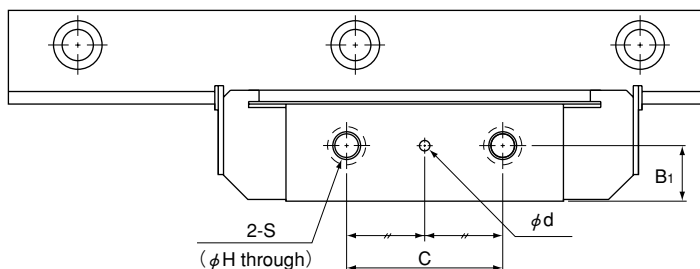
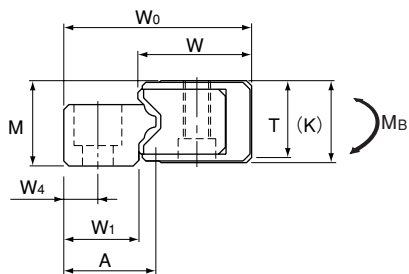

Models HR1123 to 2555M/T/TM

Unit: mm

	LM rail dimensions						Basic load rating		Static permissible moment kN-m*				Mass	
	Width	W ₄	A	Height	Pitch	d ₁ ×d ₂ ×h	C	C ₀	M _A		M _B		LM block	LM rail
	W ₁			M ₁	F				1 block	2 blocks in close contact	1 block	2 blocks in close contact		
	6.7	3.5	8.7	6.5	25	3×5.5×3	1.57	3.04	0.0229	0.17	0.0229	0.17	0.01	0.3
	9.5	5	11.6	8	40	3.5×6×4.5	2.35	4.31	0.0414	0.272	0.0414	0.272	0.03	0.5
	10.7	6	13.5	11	60	3.5×6×4.5	4.31	7.65	0.0982	0.641	0.0982	0.641	0.08	1
	15.6	8	19.5	14.5	60	6×9.5×8.5	9.9	17.2	0.308	1.91	0.308	1.91	0.13	1.8
	15.6	8	19.5	14.5	60	6×9.5×8.5	13.6	22.9	0.53	2.99	0.53	2.99	0.26	1.8
	22	10	27	18	80	9×14×12	18.6	30.5	0.783	4.41	0.783	4.41	0.43	3.2
	22	10	27	18	80	9×14×12	25.1	40.8	1.33	6.95	1.33	6.95	0.5	3.2

Note A moment in the direction M_c can be received if two rails are used in parallel. However, since it depends on the distance between the two rails, the moment in the direction M_c is omitted here.

Static permissible moment*: Static permissible moment value with one set of model HR

Models HR/HR-T/HR-M/HR-TM

Dimensional Table for Models HR/HR-T/HR-M/HR-TM

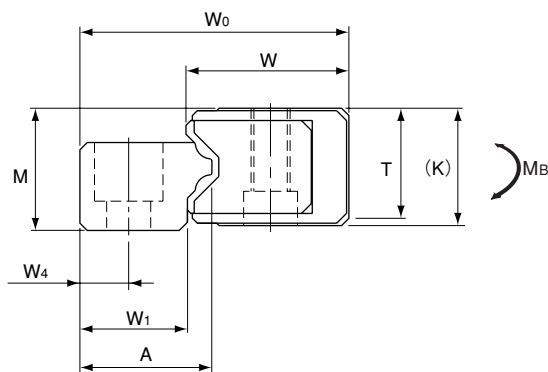

Model No.	External dimensions				LM block dimensions									
	Height M	Width W	W ₀	Length L	B ₁	C	H	S	h ₂	L ₁	T	K	Greasing hole d	D ₁
HR 3065 HR 3065T	30	40.3	65	145 173.5	19	50 80	8.6	M10	9	90 118.5	27.5	29	4	14
HR 3575 HR 3575T	35	44.9	75	154.8 182.5	21.5	60 92.5	10.5	M12	12	103.8 131.5	32	34	4	18
HR 4085 HR 4085T	40	50.4	85	177.8 215.9	24	70 110	12.5	M14	13	120.8 158.9	36	38	4	20
HR 50105 HR 50105T	50	63.4	105	227 274.5	30	85 130	14.5	M16	15.5	150 197.5	45	48	5	23
HR 60125	60	74.4	125	329	35	160	18	M20	18	236	55	58	5	26

■ Example of model number coding

2 HR4085T UU +1500L P

1 **2** **3** **4** **5**

1 No. of LM blocks used on the same rail **2** Model number **3** Dust prevention accessory symbol (see page 17) **4** LM rail length (in mm)
5 Accuracy symbol (see page 6)

Note One set of model HR means a combination of two LM rails and LM blocks used on the same plane.

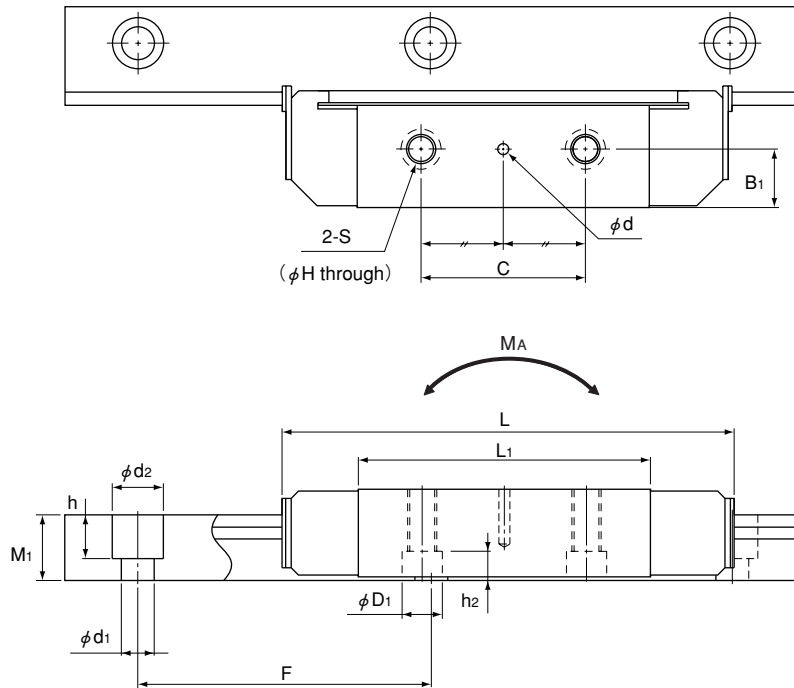

Unit: mm

	LM rail dimensions						Basic load rating		Static permissible moment kN-m*				Mass	
	Width W ₁	W ₄	A	Height M ₁	Pitch F	d ₁ ×d ₂ ×h	C kN	C ₀ kN	M _A		M _B		LM block kg	LM rail kg/m
									1 block	2 blocks in close contact	1 block	2 blocks in close contact		
	25	12	31.5	22.5	80	9×14×12	24.2	38.6	1.11	6.72	1.11	6.72	0.7	4.6
							32.1	51.6	1.89	10.4	1.89	10.4	0.9	
	30.5	14.5	37	26	105	11×17.5×14	30	47.8	1.53	8.84	1.53	8.84	1.05	6.4
							40.2	63.6	2.59	13.5	2.59	13.5	1.4	
	35	16	42.5	29	120	14×20×17	44.1	68.6	2.64	14.4	2.64	14.4	1.53	8
							59.5	91.7	4.48	23	4.48	23	1.7	
	42	20	51.5	37	150	18×26×22	70.7	107	5.15	28.9	5.15	28.9	3.06	12.1
							96	143	8.74	45.7	8.74	45.7	3.5	
	51	25	65	45	180	22×32×25	141	206	14.3	79.6	14.3	79.6	7.5	19.3

Note A moment in the direction M_c can be received if two rails are used in parallel. However, since it depends on the distance between the two rails, the moment in the direction M_c is omitted here.
 Static permissible moment*: Static permissible moment value with one set of model HR

HR

Standard Length and Maximum Length of the LM Rail

The table below shows the standard LM rail lengths and the maximum lengths of model HR variations. If the maximum length of the desired LM rail exceeds them, connected rails will be used. Contact THK for details.

For the G dimension when a special length is required, we recommend selecting the corresponding G value from the table. The longer the G dimension is, the less stable the G area may become after installation, thus adversely affecting accuracy.

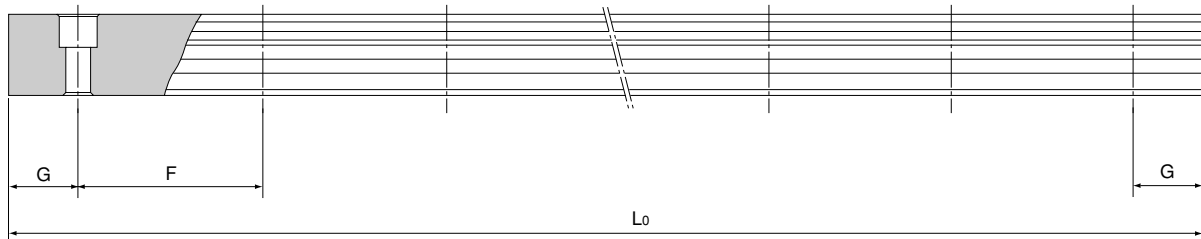

Standard Length and Maximum Length of the LM Rail for Model HR

Unit: mm

Model No.	HR 918	HR 1123	HR 1530	HR 2042	HR 2555	HR 3065	HR 3575	HR 4085	HR 50105	HR 60125
Standard LM rail length (L ₀)	70	110	160	220	280	280	570	780	1270	1530
	120	230	280	280	440	440	885	1020	1570	1890
	220	310	340	340	600	600	1200	1260	2020	2250
	295	390	460	460	760	760	1620	1500	2620	2610
			580	640	1000	1000	2040	1980		
Standard pitch F	25	40	60	60	80	80	105	120	150	180
G	10	15	20	20	20	20	22.5	30	35	45
Max length	300	500	1600	2200	2600	3000	3000	3000	3000	3000

Note 1: The maximum length varies with accuracy grades. Contact THK for details.

Note 2: If connected rails are not allowed and a greater length than the maximum values above is required, contact THK.

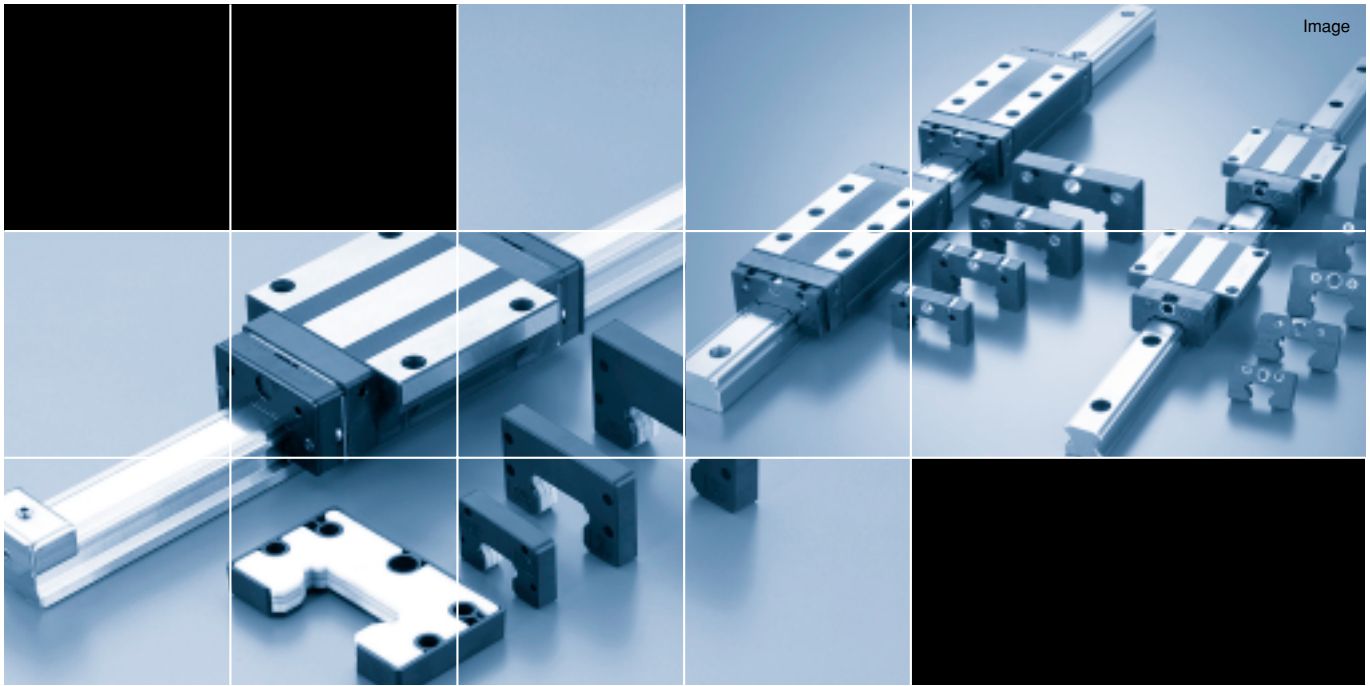

HR OPTIONS

Options

For model HR, dust-prevention accessories are available. Make a selection according to the application and the installation site.

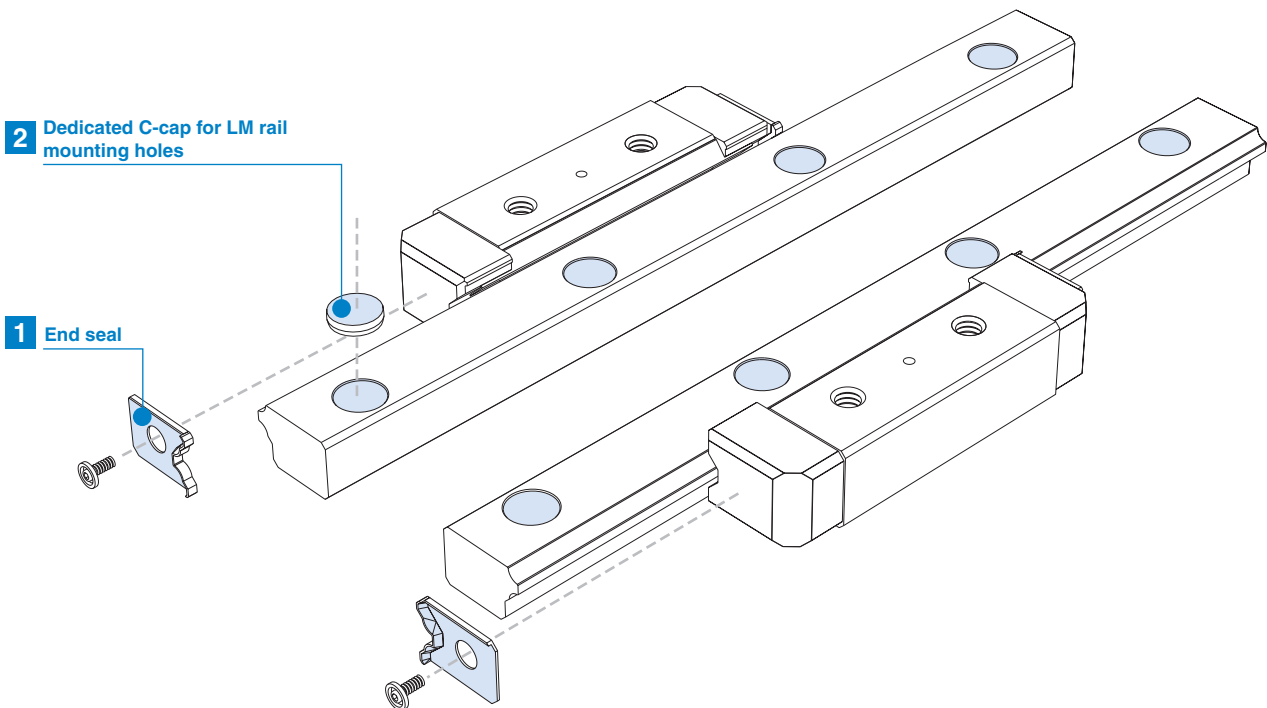

Dust Prevention Accessories

When foreign matter enters an LM system, it will cause abnormal wear or shorten the service life. It is necessary to prevent foreign matter from entering the system. Therefore, when possible entrance of foreign matter is predicted, it is important to select an effective sealing device or dust-prevention device that meets the working conditions.

1 End seal

Used in locations exposed to dust.

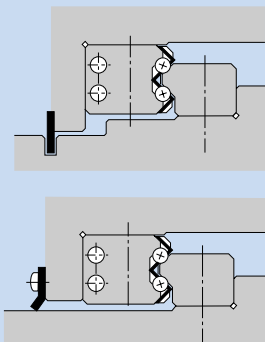
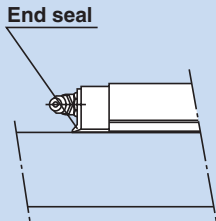

Dust Prevention Method

1 Seals

Highly wear-resistant end seals made of special synthetic rubber are available.

If desiring a dust-prevention accessory, specify it with the corresponding symbol indicated in table 2.

For the supported model numbers for dust-prevention accessories and the overall LM block length with a dust-prevention accessory attached (dimension L), see table 3.

Seal resistance value

For the maximum seal resistance value per LM block when a lubricant is applied on seals HR ... UU, refer to the corresponding value provided in table 1.

Table 1 Maximum Seal Resistance Value of Seals HR ... UU Unit: N

Model No.	Seal resistance value
918	0.5
1123	0.7
1530	1.0
2042	2.0
2555	2.9
3065	3.4
3575	3.9
4085	4.4
50105	5.9
60125	9.8

Table 2 Symbol of Dust Prevention Accessory for Model HR

Symbol	Dust prevention accessory
UU	With end seal

Table 3 Overall LM Block Length (Dimension L) of Model HR with a Dust Prevention Accessory Attached Unit: mm

Model No.	UU	Model No.	UU
918	45	3575	154.8
1123	52	3575T	182.5
1530	69	4085	177.8
2042	91.6	4085T	215.9
2042T	110.7	50105	227
2555	121	50105T	274.5
2555T	146.4	60125	329
3065	145		
3065T	173.5		

2 Dedicated C-cap

It prevents cutting chips from entering the LM rail mounting holes.

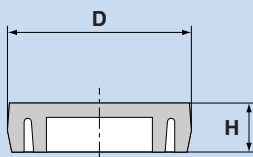

2 Dedicated C-cap for LM Rail Mounting Holes

If any of the LM rail mounting holes of an LM Guide is filled with cutting chips or foreign matter, they may enter the LM block structure. Entrance of such foreign matter can be prevented by covering each LM rail mounting hole with the dedicated cap so that the top of the mounting holes is on the same level as the LM rail top face.

The dedicated C-cap for LM rail mounting holes is highly durable since it uses a special synthetic resin with high oil resistance and high wear resistance.

When placing an order, specify the desired cap type with the corresponding cap number indicated in the table on the right.

Model No.	C-cap model No.	Bolt used	Major dimensions mm	
			D	H
1123	C 3	M 3	6.3	1.2
1530	C 3	M 3	6.3	1.2
2042	C 5	M 5	9.8	2.4
2555	C 8	M 8	14.4	3.7
3065	C 8	M 8	14.4	3.7
3575	C10	M10	18.0	3.7
4085	C12	M12	20.5	4.7
50105	C16	M16	26.5	5.7

Lubrication

The LM block has a greasing hole in the center of its top face. To provide lubrication through this hole, the table must be machined to also have a greasing hole as shown in the figure on the right and attach a grease nipple or the like. When using oil lubrication, it is necessary to identify the lubrication route. Contact THK for details.

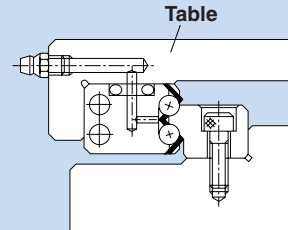

Example of Machining a Greasing Hole

Dedicated Mounting Bolt

Normally, when mounting the LM block with which to adjust a clearance, use the tapped hole provided on the LM block to secure it as shown in Fig. 1.

In this case, the hole must be machined so that its diameters d_1 and D_1 are larger by the adjustment allowance.

If it is inevitable to use the mounting method as indicated by Fig. 2 for a structural reason. The dedicated mounting bolt as shown in Fig. 3 is required for securing the LM block. Be sure to specify that the dedicated mounting bolt is required when ordering the LM Guide.

Dedicated Mounting Bolt

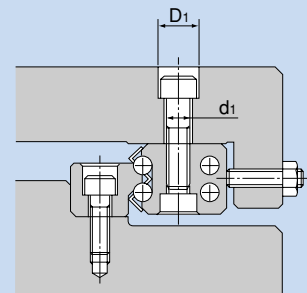

Fig. 1

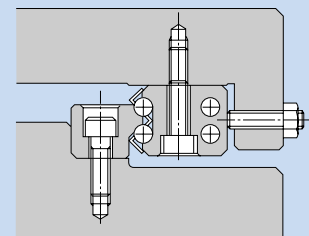

Fig. 2

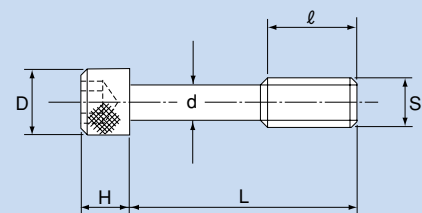

Fig. 3

Dedicated Mounting Bolt

Unit: mm

Model No.	S	d	D	H	L	l	Supported model
B 3	M3	2.4	5.5	3	17	5	HR 1530
B 5	M5	4.1	8.5	5	22	7	HR 2042
B 6	M6	4.9	10	6	28	9	HR 2555
B 8	M8	6.6	13	8	34	12	HR 3065
B10	M10	8.3	16	10	39	15	HR 3575
B12	M12	10.1	18	12	45	18	HR 4085
B14	M14	11.8	21	14	55	21	HR 50105
B16	M16	13.8	24	16	66	24	HR 60125

THK LM Guide Model HR

Precautions on use

● Handling

- Disassembling components may cause dust to enter the system or degrade mounting accuracy of parts. Do not disassemble the product.
- Tilting an LM block or LM rail may cause them to fall by their own weight.
- Dropping or hitting the LM Guide may damage it. Giving an impact to the LM Guide could also cause damage to its function even if the guide looks intact.

● Lubrication

- Thoroughly remove anti-corrosion oil and feed lubricant before using the product.
- Do not mix lubricants of different physical properties.
- In locations exposed to constant vibrations or in special environments such as clean rooms, vacuum and low/high temperature, normal lubricants may not be used. Contact THK for details.
- When planning to use a special lubricant, contact THK before using it.
- When adopting oil lubrication, the lubricant may not be distributed throughout the LM system depending on the mounting orientation of the system. Contact THK for details.
- Lubrication interval varies according to the service conditions. Contact THK for details.

● Precautions on Use

- Entrance of foreign matter may cause damage to the ball circulating path or functional loss. Prevent foreign matter, such as dust or cutting chips, from entering the system.
- When planning to use the LM system in an environment where coolant penetrates the LM block, it may cause trouble to product functions depending on the type of coolant. Contact THK for details.
- Do not use the LM system at temperature of 80°C or higher. When desiring to use the system at temperature of 80°C or higher, contact THK in advance.
- If foreign matter adheres to the LM system, replenish the lubricant after cleaning the product. For available types of detergent, contact THK.
- When using the LM Guide with an inverted mount, breakage of the endplate due to an accident or the like may cause balls to fall out and the LM block to come off from the LM rail and fall. In these cases, take preventive measures such as adding a safety mechanism for preventing such falls.
- When using the LM system in locations exposed to constant vibrations or in special environments such as clean rooms, vacuum and low/high temperature, contact THK in advance.
- When removing the LM block from the LM rail and then replacing the block, an LM block mounting/removing jig that facilitates such installation is available. Contact THK for details.

● Storage

- When storing the LM Guide, enclose it in a package designated by THK and store it in a horizontal orientation while avoiding high temperature, low temperature and high humidity.

● “LM Guide,” “Ball Cage,” “,” and “QZ” are registered trademarks of THK CO., LTD.

- The photo may differ slightly in appearance from the actual product.
 - The appearance and specifications of the product are subject to change without notice. Contact THK before placing an order.
 - Although great care has been taken in the production of this catalog, THK will not take any responsibility for damage resulting from typographical errors or omissions.
 - For the export of our products or technologies and for the sale for exports, THK in principle complies with the foreign exchange law and the Foreign Exchange and Foreign Trade Control Law as well as other relevant laws.
- For export of THK products as single items, contact THK in advance.

All rights reserved

THK CO., LTD.

HEAD OFFICE 3-11-6, NISHI-GOTANDA, SHINAGAWA-KU, TOKYO 141-8503 JAPAN

ASIA PACIFIC SALES DEPARTMENT PHONE:(03)5434-0351 FAX:(03)5434-0353

NORTH AMERICA

CHICAGO

PHONE:(847)310-1111 FAX:(847)310-1182

NEW JERSEY

PHONE:(201)529-1950 FAX:(201)529-1962

ATLANTA

PHONE:(770)840-7990 FAX:(770)840-7897

LOS ANGELES

PHONE:(714)891-6752 FAX:(714)894-9315

SAN FRANCISCO

PHONE:(925)455-8948 FAX:(925)455-8965

BOSTON

PHONE:(781)575-1151 FAX:(781)575-9295

DETROIT

PHONE:(248)858-9330 FAX:(248)858-9455

TORONTO

PHONE:(905)712-2922 FAX:(905)712-2925

BRASIL (SÃO PAULO)

PHONE:(011)3767-0100 FAX:(011)3767-0101

EUROPE

DÜSSELDORF

PHONE:0049-(0)2102-7425-0 FAX:0049-(0)2102-7425-299

STUTTGART

PHONE:0049-(0)7150-9199-0 FAX:0049-(0)7150-9199-888

MÜNCHEN

PHONE:0049-(0)89-3706160 FAX:0049-(0)89-37061626

U.K.

PHONE:0044(0)1908-303050 FAX:0044(0)1908-303070

MILANO

PHONE:0039-039-2842079 FAX:0039-039-2842527

BOLOGNA

PHONE:0039-051-6412211 FAX:0039-051-6412230

SWEDEN

PHONE:0046-(0)8-4457630 FAX:0046-(0)8-4457639

AUSTRIA

PHONE:0043-(0)7229-51400 FAX:0043-(0)7229-51400-79

SPAIN

PHONE:0034-93-652-5740 FAX:0034-93-652-5746

THK FRANCE S. A. S.

PHONE:0033-(0)4-37491400 FAX:0033-(0)4-37491401

SOUTH AFRICA

PHONE:0027-(0)44-2720020 FAX:0027-(0)44-2720020

CHINA

THK SHANGHAI CO.,LTD.

PHONE:(21)6334-5131 FAX:(21)6334-5137

BEIJING

PHONE:(10)6590-3259 FAX:(10)6590-3557

THK SHOUZAN CO.,LTD.

PHONE:2376-1091 FAX:2376-0749

TAIWAN

TAIPEI

PHONE:(02)2888-3818 FAX:(02)2888-3819

TAICHUNG

PHONE:(04)2359-1505 FAX:(04)2359-1506

SOUTHERN

PHONE:(06)289-7668 FAX:(06)289-7669

KOREA (SEOUL)

PHONE:(02)3468-4351 FAX:(02)3468-4353

MALAYSIA (KUALA LUMPUR)

PHONE:(03)9287-1137 FAX:(03)9287-8071

INDIA (BANGALORE)

PHONE:(080)2330-1524 FAX:(080)2330-1524

